

SONIC-PRO[®] Hybrid Ultrasonic Flowmeter



Model S3C1JA

- Selectable Doppler or Transit Time
- Non-Invasive clamp on transducers
- 1/2" thru 100" Diameter Pipe Sizes
- High quality QVGA display
- NEMA 4X (IP 66) washdown enclosure
- Full function front panel interface
- "Smart" external communications
- Process control features
- 2 Year warranty
- Includes portable carrying case

💧 Liquid applications

NEMA 4X





Applications:

- Sewage
- Wastewater
- Pulp & Paper Slurries
- DI water
- Discharge water
- Caustics
- Chemical Slurries
- Ground water
- Food and Beverage
- Petrochemical
- Any sound conducting liquid

Features:

- Selectable Doppler or Transit Time operating mode.
- Custom quality metric algorithms and DSP technology ensures reliable, high accuracy measurements.
- Quick and easy clamp-on transducer installation. Proprietary AGC (Automatic Gain Control) algorithm eliminates manual gain adjustment.
- Three display options: user programmable via 5-button menu driven interface (S3 option), display without menu access (S2 option) and no display (S1 option).
- Factory configured for easy installation. Includes five user programmable, password protected configurations for multiple user and portable applications.
- High quality 320 x 240 pixel QVGA backlit LCD.
- Data logging to standard SD Card format. User configurable to time interval, flow rate and total set-point triggers. 500,000 events with included 32MB SD Card.
- Isolated 4-20 mA output - fully configurable.
- 0 - 1000Hz Pulse output - fully configurable.
- Optional computer connection via RS-232, RS-485, USB, Ethernet. Permits remote access and control of all functions including real-time display, system configuration, data logging, remote data capture and process control functions. Software permits remote internet access through local network set-up.
- Optional process control via three independently configurable 10 amp, form C relays. Configure to flow rate for high/low/range rate alarm or to flow total for either manual trigger batch operations or flow triggered batch operations.

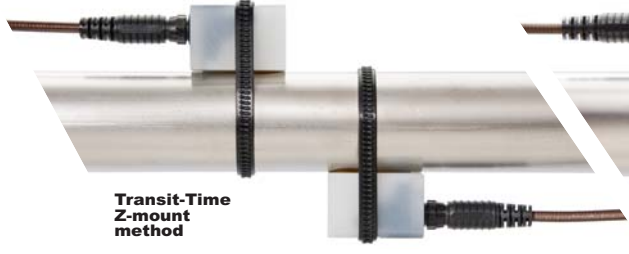
Transducer Options:

 <p>Doppler mount method</p>	 <p>Transit-Time Z-mount method</p>	 <p>Transit-Time V-mount method</p>
<p>Metal Clamp-On</p>	<p>Plastic Clamp-On</p>	<p>Plastic Clamp-On</p>
<p>For pipe sizes 2" to 100" Doppler mount, V-mount, or Z-mount methods</p>	<p>For Pipe Sizes 2" thru 100" Doppler mount, V-mount, or Z-mount methods</p>	<p>For Pipe Sizes 1/2" thru 2" Doppler mount, V-mount, or Z-mount methods</p>
<p>Model A Without T-Track mounting system</p>	<p>Model D Without T-Track mounting system Model E With single T-Track mounting system for V mount 1/2" thru 4" pipe installations Model F With dual T-Track mounting system for V or Z mount 1/2" thru 4" pipe installations Model G With single T-Track mounting system for V mount 2" thru 14" pipe installations Model H With dual T-Track mounting system for V or Z mount 2" thru 24" pipe installations</p>	<p>Model I Without T-Track mounting system Model J With single T-Track mounting system for V mount 1/2" thru 4" pipe installations Model K With dual T-Track mounting system for V or Z mount 1/2" thru 4" pipe installations</p>
<p>NOTE: For Transit-Time applications, the V-mount method - which reflects the sound beam off the opposite pipe wall - may be used on most plastic pipes up to 14" diameter and on most metal pipes up to 6" diameter. However, when attempting to measure through thick pipe walls, or dense fluids or fluids with high particulate matter, the Z-mount method - where the sound beam is directed straight across the pipe inside diameter without reflection - is recommended for additional signal strength. The Z-mount method is recommended for plastic pipes >14" diameter and metal pipe >6" in diameter.</p>		

T-Track Single for V-Mount:

The single **T-Track** mounting system is designed to quickly and accurately mount the Sonic-Pro transducers (plastic models only) in the V-Mount method. Two pipe size options are available; 1/2" to 4" and 2" to 14" diameter pipes. The **T-Track's** built-in ruler and mounting base ensure the transducers are perfectly aligned and spaced. The T-Track's heavy gauge Stainless Steel cover, anodized aluminum end blocks and polymeric tensioning clamps also provide protection for the transducers for years of service in tough environments.



1/2" to 4" pipe model shown in V-mount

T-Track Dual for V or Z-Mount:

When additional signal strength is needed, a dual **T-Track** system can be used which is designed to quickly and accurately mount the Sonic-Pro transducers (plastic models only) in either the V-mount or the Z-Mount method. Two pipe size options are available; 1/2" to 4" and 2" to 24" diameter pipes. The **T-Track's** built-in ruler, mounting base and alignment rods ensure the transducers are perfectly aligned and spaced. Contact the factory for T-Track applications on pipes greater than 24" diameter.



2" to 24" pipe model shown in Z-mount

Cable and Connector options:

Metal Transducer Cable & Connector



Plastic Transducer Cable & Connector



Plastic Transducer Cable & Connector



Display Options:



Model S3 Display

The S3 display option allows full access to the configuration menus directly from the front panel Keypad.

Display
320 x 240 pixel QVGA backlit LCD

Display Languages
English, Spanish, French or German.

Keypad
Five-button tactile switch keypad.

Security
Master and configuration passwords.

Display Volume Units
Configurable Rate and Total units. Rate display in feet or meters per second.

Display Time Units
Seconds, minutes, hours, days.



Model S2 Display

The S2 display option allows the user to clear the accumulated total to zero (if allowed by configuration) and to swap the rate and total display fonts. Access to the configuration menu is not available from the keypad.

The meter is factory set for one pipe application only. Pipe material and dimensional changes, fluid selections, output signal scaling, and other features of the meter are not accessible.

The communications option is required to access to the configuration menus.

Display
320 x 240 pixel QVGA backlit LCD



Model S1 Display

The S1 display option does not include a local display.

The meter is factory set for one pipe application only. Pipe material and dimensional changes, fluid selections, output signal scaling, and other features of the meter are not accessible.

The communications option is required to access to the configuration menus.

Display
None.

Communications Options:

Any Sonic-Pro model can be equipped with a **Communications Package** that includes Ethernet, USB, RS-232, and RS-485 connections, and proprietary Sonic-Pro User PC Software. When connected to a PC computer running the Sonic-Pro software, the user can access the configuration menu for program editing and data logging downloads directly into a PC.

The Sonic-Pro Software user interface mimics the S3 model 5-button touch pad so learning to use the software application is simple. Simply clicking on the buttons is the same as pressing the buttons on the Sonic-Pro SPU touch pad. Pressing and holding shift while clicking on a button simulates pressing and holding a button on the touch pad.

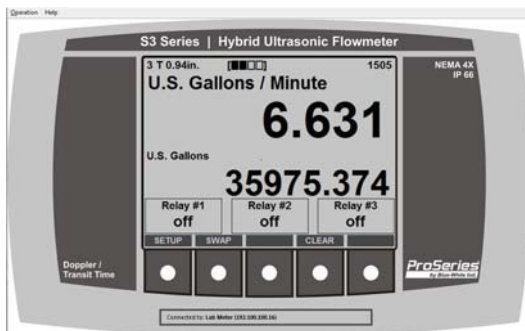

Process Control Options:

Any Sonic-Pro model can be equipped with a **Process Control Relay Package** that includes three independently programmable 10 amp relays. However, relay programming requires the Model S3 programming features or the Communications package to function. Models S1 and S2 cannot access the relay functions unless connected to the communications Software.

Each relay can be configured to respond to changes in either the measured *rate* of flow or the accumulated *total* flow value. When assigned to monitor flow rate, high/low/range rate alarms are possible. When assigned to monitor accumulated total, manual trigger batch operations or automatically triggered, timed batch (proportional feed) operations are possible.



Application Qualifier:

Fluid Requirements

Doppler Operation	Transit Time Operation
<ul style="list-style-type: none"> • Must conduct sound • Must contain sound reflecting particles such as air bubbles, sand, etc. <p>Doppler measurement requires 0.02% to 15% (200 to 150,000 ppm) particles be present in the flow stream to “reflect” the sound waves.</p>	<ul style="list-style-type: none"> • Must conduct sound • Must be relatively clean fluid <p>Transit Time measurement requires relatively “clean” fluid. Fluids containing from 0% to 10% (0 to 100,000 ppm) of particles are acceptable.</p>

Note: Do not attempt to measure very low flow velocities in the Doppler mode, the particles can fall out of suspension resulting in error or failure.

Pipe Requirements:

Pipe Material	Pipe Size Ranges and Maximum Wall Thickness			
	Transducer Models I, J, K	Transducer Models A, D, E, F, G, H		Max Wall
	Doppler or Transit Time Mode	Doppler Mode	Transit Time Mode	
Metal Pipes (typical)	3/4" to 2" (20 to 63mm)	2" to 100" (63 to 2500mm)	2" to 100" (63 to 2500mm)	.500" (13mm)
Plastic Pipes (typical)	1/2" to 2" (20 to 63mm)	1" to 100" (25 to 2500mm)	1-1/2" to 100" (40 to 2500mm)	2.00" (50mm)
FRP (fiberglass Reinforced Plastic)	1/2" to 2" (20 to 63mm)	2" to 100" (63 to 2500mm)	2" to 100" (63 to 2500mm)	.500" (13mm)
Polyethylene (LDPE)	1/2" to 2" (20 to 63mm)	1" to 100" (25 to 2500mm)	1-1/2" to 100" (40 to 2500mm)	1.00" (25mm)
Polypropylene	1/2" to 2" (20 to 63mm)	1" to 100" (25 to 2500mm)	1-1/2" to 100" (40 to 2500mm)	.500" (13mm)

Note: The outside surface of the pipe must be clean and smooth. Insulation, coatings, rust and other surface imperfections should be removed before installing the transducers. The inside surface of the pipe must be smooth to properly reflect the sound wave.

Recommended Transducer Mounting Methods

Pipe Size	Plastic Pipes		Metal Pipes	
	With T-Track	Without T-Track	With T-Track	Without T-Track
1/2"	V or W	N/A	V or W	N/A
3/4"	V or W	N/A	V or W	N/A
1"	V	N/A	V	N/A
1-1/2"	V	V	V	V
2"	V	V	V	V
3"	V	V	V	V
4"	V	V	V	V
6"	V	Z	V	Z
8"	V	Z	Z	Z
10"	V	Z	Z	Z
12"	V	Z	Z	Z
>12"	Z	Z	Z	Z

Straight Lengths of Pipe Requirements

Type of Disturbance	Straight Lengths of Pipe Required	
	Upstream from Transducers	Downstream from Transducers
Flange	5 x Nominal Pipe Size	5 x Nominal Pipe Size
Reducer	7 x Nominal Pipe Size	5 x Nominal Pipe Size
90° Elbow	10 x Nominal Pipe Size	5 x Nominal Pipe Size
Two 90° Elbows - 1 Direction	15 x Nominal Pipe Size	5 x Nominal Pipe Size
Two 90° Elbows - 2 Directions	20 x Nominal Pipe Size	5 x Nominal Pipe Size
Gate valve	25 x Nominal Pipe Size	5 x Nominal Pipe Size
Pump	25 x Nominal Pipe Size	5 x Nominal Pipe Size

Note: The Sonic-Pro’s sound wave beam is only affected by fluid that actually passes through the beam and therefore, the meter will not measure with high accuracy if the fluid velocity is not consistent across the entire pipe diameter. Flow disturbances such as pumps, elbows, tees, and valves in the flow stream can cause swirl patterns and vortices that will affect the measurement. Install the transducers on a straight run of pipe **as far as possible** from any disturbances. The distance required for high accuracy will depend on the type of disturbance.

Installation:

Fluid Requirements

The **Sonic-Pro** series **Hybrid Ultrasonic Flow Meters** can measure fluid flow in virtually any fluid in which sound waves can travel. The **Sonic-Pro** meters are considered "hybrid" because they can measure fluid flow using either the Doppler or Transit Time methods. The **Sonic-Pro** ultrasonic sound transducers are clamped to the outside of the pipe wall and include no moving parts. This method of flow measurement is safe, non-intrusive and very easy to service.

The Doppler measurement method requires particles be present in the flow stream to "reflect" the sound waves. The meter may be operated in the Doppler mode when the fluid contains 0.02% to 15% (200 to 150,000 ppm) of particles .

The Transit Time measuring method requires relatively "clean" fluid to enable the sound waves to complete their circuit. The meter may be operated in the Transit-Time mode when the fluid contains 0% to 10% (0 to 100,000 ppm) of particles. To allow for changes in the fluid's particle count, the **Sonic-Pro** monitors the signal gain and employs an Automatic Gain Control (AGC) algorithm that periodically adjusts the gain maintain the optimum power level.

The speed at which sound travels in the fluid must be known. The factory will configure the meter for a known fluid during the initial configuration. The **Sonic-Pro** model **S3c** includes a 5-button user interface and remote PC software that can be used to configure the meter. Many common fluids are listed in the software and can be selected directly from the menu. Provided the speed of sound in the fluid is known, custom "unknown" fluids can be input manually by the user. A list of various fluids and their sound speeds are provided in the user manual.

Flow Stream Requirements

The Sonic-Pro's sound wave beam is only affected by fluid that actually passes through the beam and therefore, the meter will not measure accurately if the fluid velocity is not consistent across the entire pipe diameter. Flow disturbances such as pumps, elbows, tees, and valves in the flow stream can cause swirl patterns and vortices that will affect the measurement. Install the transducers on a straight run of pipe **as far as possible** from any disturbances. The distance required for accuracy will depend on the type of disturbance.

Minimum Straight Pipe Length Requirements

The meter's accuracy is affected by disturbances such as pumps, elbows, tees, valves, etc., in the flow stream. Install the meter in a straight run of pipe **as far as possible** from any disturbances. The distance required for accuracy will depend on the type of disturbance.

Type of Disturbance	Straight Lengths of Pipe Required	
	Upstream from Transducers	Downstream from Transducers
Flange	5 x Nominal Pipe Size	5 x Nominal Pipe Size
Reducer	7 x Nominal Pipe Size	5 x Nominal Pipe Size
90° Elbow	10 x Nominal Pipe Size	5 x Nominal Pipe Size
Two 90° Elbows - 1 Direction	15 x Nominal Pipe Size	5 x Nominal Pipe Size
Two 90° Elbows - 2 Directions	20 x Nominal Pipe Size	5 x Nominal Pipe Size
Gate valve or Pump	25 x Nominal Pipe Size	5 x Nominal Pipe Size

Transducer Mounting Location

- The meter can be mounted on horizontal or vertical runs of pipe.
- Mounting on the sides (3 o'clock and 9 o'clock) position on horizontal pipe is recommended.
- Mounting anywhere around the diameter of vertical pipe is acceptable, however, the pipe must be completely full of fluid at all times.
- Back pressure is required on downward flows to ensure a full pipe.
- See the minimum straight length of pipe requirement chart above.
- The meter will measure flow from either direction as positive.

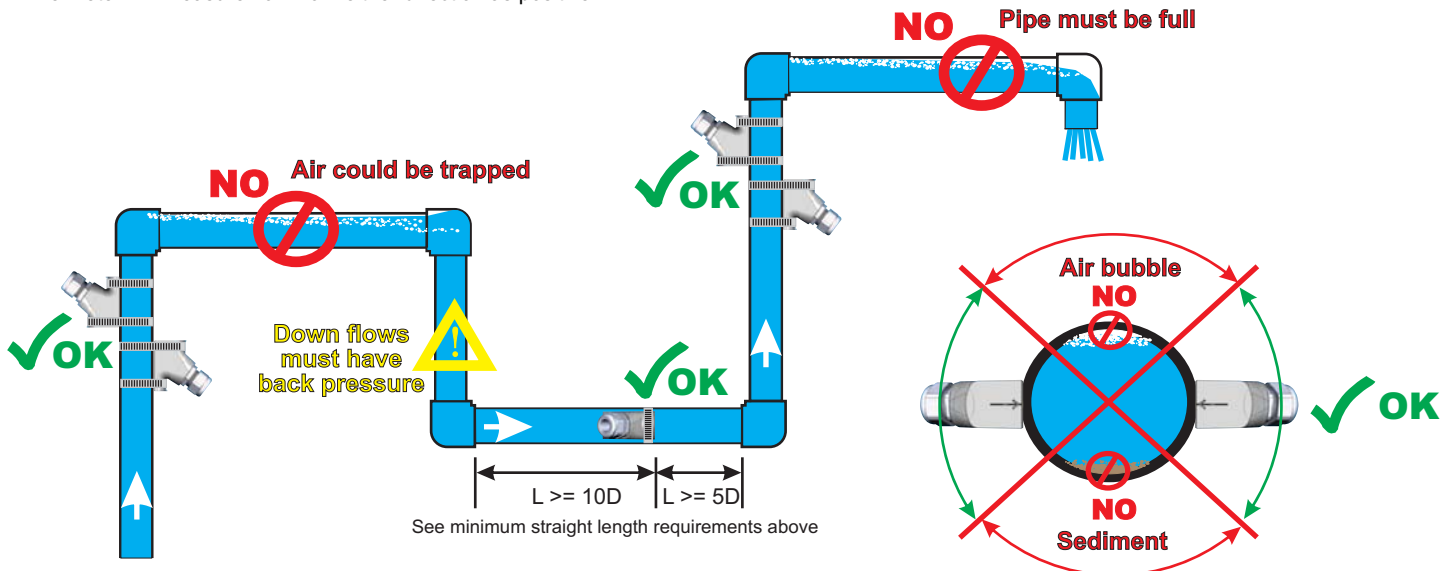

Specifications:

General Operation

Measuring Principle

Hybrid. User-selectable Doppler or Transit Time operating modes.

Fluid Types

Virtually any acoustically conductive fluid.

Transit time mode from 0% to 10% (0 to 100,000 ppm) particulate.

Doppler from 0.02% to 15% (200 to 150,000 ppm) 50 micron particles.

Fluid Velocity Range

0.25 to 30 feet per second (0.07 to 9 meters per second)

Flow Sensitivity

0.001 feet per second (0.0003 meters per second)

Nominal Pipe Sizes

0.5 inch - 100 inch (20mm to 2500mm)

Pipe Liner Materials

Most plastic liners

Pipe Materials

Most metal and plastic pipes.

Accuracy

Flow Rate Averaging Time	Transit Time Accuracy at at Nominal Pipe Sizes	
5.0 Seconds (default setting)	+/-1% of rate > 1 ft/sec	+/-0.01 ft/sec < 1 ft/sec
1.0 Seconds	+/-1% of rate > 5 ft/sec	+/-0.05 ft/sec < 5 ft/sec
0.5 Seconds	+/-2% of rate > 12 ft/sec	+/-0.25 ft/sec < 12 ft/sec
Doppler Accuracy at Nominal Pipe Sizes		
5.0 Seconds (default setting)	+/-2% of rate > 5 ft/sec	+/-0.10 ft/sec < 5 ft/sec
1.0 Seconds	+/-2% of rate > 8 ft/sec	+/-0.20 ft/sec < 8 ft/sec
0.5 Seconds	+/-2% of rate > 12 ft/sec	+/-0.25 ft/sec < 12 ft/sec

Shipping Specifications

Carton Dimensions: 21" x 17" x 9-1/2"

Carton Weight: 24 lbs. (10.9 Kg.)

(excluding T-Track mounting fixtures)

Clamp-On Transducers - Model A

Housing

NEMA 6P (IP67), Nickel plated aluminum, SS clamps & hardware.

Dimensions: 3.12H x 2.95W x 1.60D in. (79H x 75W x 41D mm)

Weight (excluding cable): 0.8 lb. (0.4 kg.) each

Cable - non-removable

Shielded coaxial RG/U Type: 59. PVC jacket, black. RoHS Compliant

Available lengths: 10ft (3m), 25 ft. (7m), 50 ft. (15m), 100 ft. (30m)

Pipe Surface Temperature

-20°F to 250°F (-34°C to 121°C)

Clamp-On Transducers - Models D thru K

Housing

NEMA 6P (IP67), PVDF base with Polypropylene cover.

Dimensions: 3.12H x 2.95W x 1.60D in. (79H x 75W x 41D mm)

Weight (excluding cable): 0.8 lb. (0.4 kg.) each

Cable - field replaceable options A, B, C, D

Shielded coaxial RG/U Type: 59. FEP jacket, black. RoHS Compliant

Connector: thermoplastic locking. NEMA 6P (IP67)

Available lengths: 10ft (3m), 25 ft. (7m), 50 ft. (15m), 100 ft. (30m)

Cable - non-removable options E, F, G, H

Shielded coaxial RG/U Type: 59. FEP jacket, black. RoHS Compliant

Available lengths: 10ft (3m), 25 ft. (7m), 50 ft. (15m), 100 ft. (30m)

Pipe Surface Temperature

-20°F to 250°F (-34°C to 121°C)

T-Track mounting system -

Housing cover: Heavy gauge 304 stainless steel

Pipe surface mounting V-blocks: Anodized aluminum

Pipe Clamps (1/2" - 4" models): Nylon 6/6

Pipe Clamps (2" - 24" models): 1" x 96" polypropylene strap, SS ratchet

Hardware: stainless steel

SPU (Signal Processing Unit)

Enclosure

NEMA 4X (IP66), Powder coated aluminum, SS clamps and hardware.

Dimensions: 11.00H x 8.60W x 5.00D inches (279H x 218W x 127D mm)

Weight 9.5 lb. (4.3 Kg.)

Mounting

Wall, pipe (vertical or horizontal) or panel mounting. Hardware included.

Panel opening: 10.63H x 8.10W inches (270H x 206W mm)

Panel Depth. Rear: 2.78 inches (71 mm), Front : 2.18 inches (55 mm)

Power Requirements

95-264 VAC 50/60Hz or 15-30 VDC; 30 watts maximum

Operating Temperature

14°F to 140°F (-10°C to 60°C) **Storage:** -40°F to 158°F (-40°C to 70°C)

Display

320 x 240 pixel QVGA backlit LCD, UV resistant.

Simultaneous Rate and Total: 10 digit maximum + exponent to E+32

Decimal location configurable to 10 places.

Display Languages

English, Spanish, French or German selectable.

Keypad

Five-button positive action tactile switch keypad.

Security

Programmable master password and individual configuration passwords.

Display Volume Units

Independently configurable Rate and Total display units in: U.S. Gallons,

ounces, barrels (US liquid), barrels (US oil), cubic ft, acre ft, Imperial

(British) gallons, liter, cubic meter, or user defined "custom" units.

Rate display in feet or meters per second.

Display Time Units

Seconds, minutes, hours, days.

Display/Output Response Time

Selectable: 0.25, 0.50, 1.0 (default), 2.5, 5.0 seconds.

Flow Rate Display Averaging

Selectable: 0.50, 1.0, 2.5, 5.0 (default), 10.0 seconds.

Data Outputs

- Isolated 4-20 mA output - fully configurable, invertible
- 0-1000 Hz Pulse output - fully configurable, invertible

Data Logging

Date/time stamped flow rate and flow total data in FAT32 file format, easily

imported into Excel. Configurable to trigger on time interval (1-999,999

sec), rate and/or total set-point values. Over 500,000 log events possible

with included 32MB SD Card. 2,000 logs held in memory buffer

downloadable using Sonic-Pro user software application.

Process Control

Three independently configurable 10 amp Form C, NO/NC relays.

- Configure to flow rate for high/low/range rate alarm. Programmable release values enable auto release or manual latching operation.
- Configure to flow total for manual trigger batch operations or automatically triggered, timed batch operations.

External Communications

Computer connection via RS-232, RS485, USB, Ethernet.

- Includes user communication and configuration application software
- Permits remote internet access through local network set-up
- Remotely access and upload data logging files.

Dimensions:

Sonic-Pro SPU

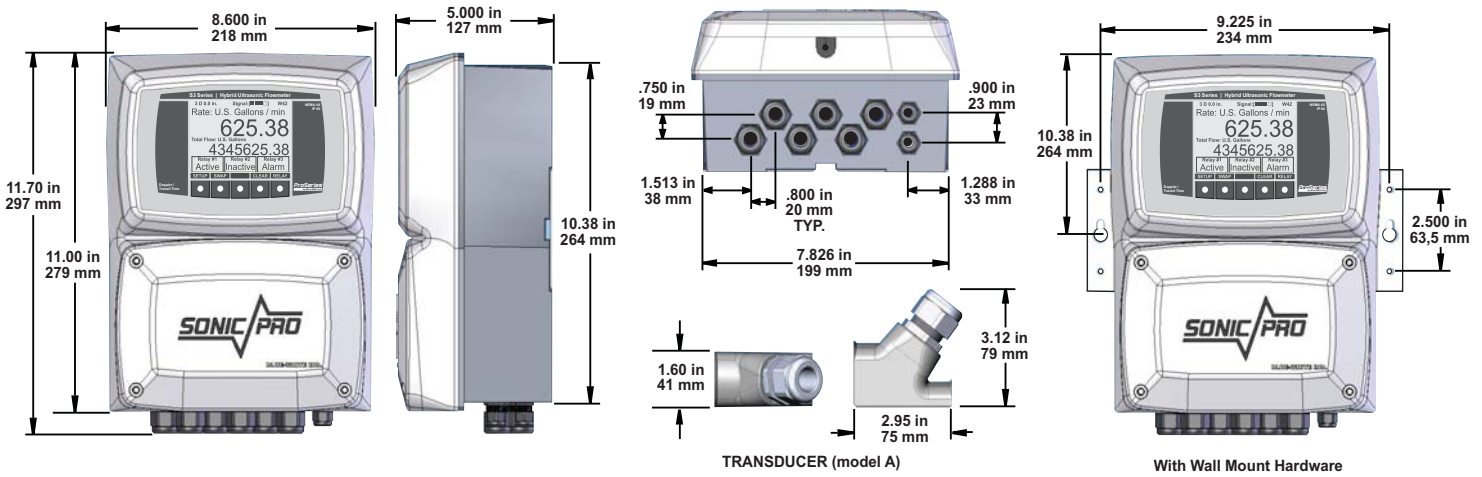

1/2" - 4" T-Track shown in V-mount

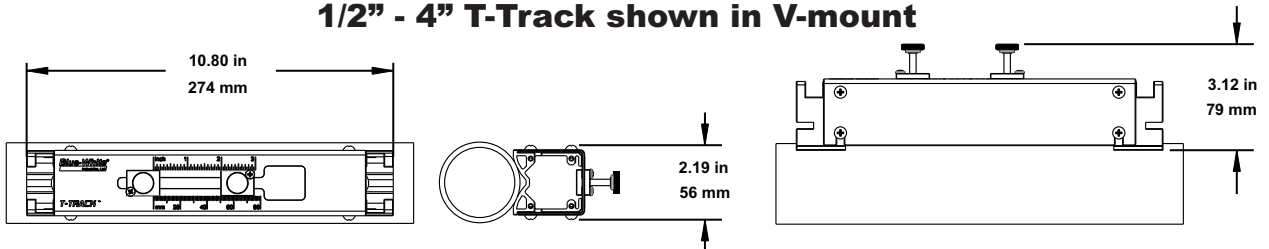

2" - 24" T-Track shown in Z-mount

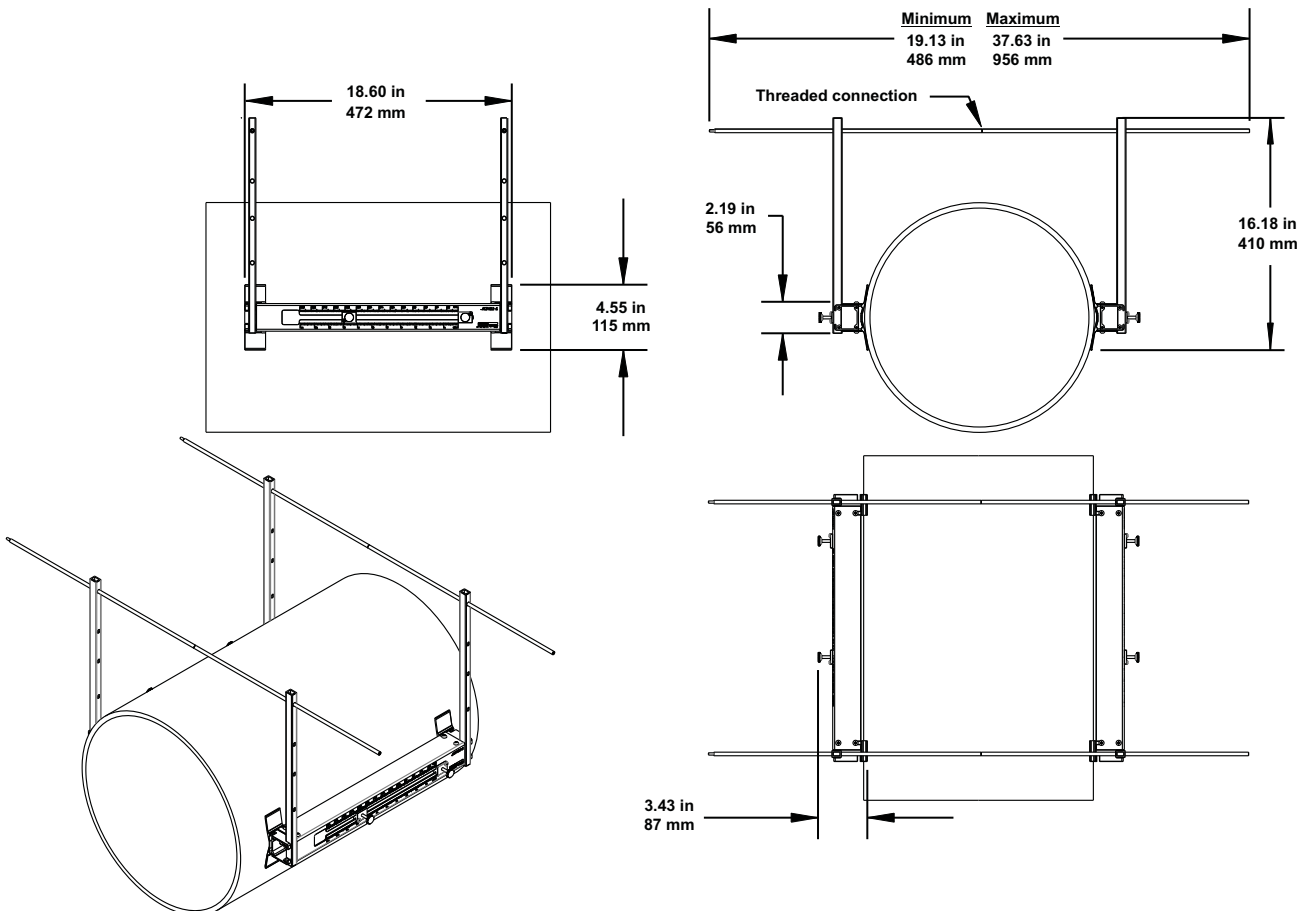

Model Number Matrix:

Sonic-Pro Part Number Matrix

Signal Processing Unit (SPU) and Display Options

S1	Model S1 - Factory configured - without display - no configuration menu access ¹
S2	Model S2 - Factory configured - with display - no configuration menu access ¹
S3	Model S3 - Factory configured - with display and with user configurable menu access

Smart Communications and Control Options ²

A	Communications Includes Ethernet, USB, RS-232, RS-485 connections and user configuration and monitoring PC software.
B	Process Control Includes three 10 amp, Form C relays. Note: requires S3 configurable display or the communications option "A" above.
C	Both communications and Process Control options.
X	None

Power Supply Cord

0	Ships without power cord or AC/DC transformer
1	U.S. 125V with NEMA 5/15 plug
2	European 250V with CEE 7/VII plug
3	U.S. 250V with NEMA 6/15 plug
8	Australia/New Zealand 250V with AS 3112 plug
X	Power cord without attachment plug

Transducer Model

A	2" to 100" Pipe Size Range - Metal Housing Clamp-on Transducer - non-removable liquid tight cable gland connector only
D	2" to 100" Pipe Size Range - Plastic Housing Clamp-on Transducer - without T-Track mounting fixture
E	2" to 100" Pipe Size Range - Plastic Housing Clamp-on Transducer - single, V-mount T-Track (½"- 4" pipes sizes only)
F	2" to 100" Pipe Size Range - Plastic Housing Clamp-on Transducer - dual, Z-mount T-Track (½"- 4" pipes sizes only)
G	2" to 100" Pipe Size Range - Plastic Housing Clamp-on Transducer - single, V-mount T-Track (2"- 14" pipes sizes only)
H	2" to 100" Pipe Size Range - Plastic Housing Clamp-on Transducer - dual, Z-mount T-Track (2"- 24" pipes sizes only)
I	½" to 2" Pipe Size Range - Plastic Housing Clamp-on Transducer - without T-Track mounting fixture
J	½" to 2" Pipe Size Range - Plastic Housing Clamp-on Transducer - single, V-mount T-Track (½"- 4" pipes sizes only)
K	½" to 2" Pipe Size Range - Plastic Housing Clamp-on Transducer - dual, Z-mount T-Track (½"- 4" pipes sizes only)
X	No Transducers

Transducer Cable Length and Connection Type

1	10 ft cable length - non-removable liquid-tight cable gland - not field replaceable - Metal Transducers only
2	25 ft cable length - non-removable liquid-tight cable gland - not field replaceable - Metal Transducers only
3	50 ft cable length - non-removable liquid-tight cable gland - not field replaceable - Metal Transducers only
4	100 ft cable length - non-removable liquid-tight cable gland - not field replaceable - Metal Transducers only
A	10 ft cable length - with removable liquid-tight cable plug and socket - field replaceable - Plastic Transducers only
B	25 ft cable length - with removable liquid-tight cable plug and socket - field replaceable - Plastic Transducers only
C	50 ft cable length - with removable liquid-tight cable plug and socket - field replaceable - Plastic Transducers only
D	100 ft cable length - with removable liquid-tight cable plug and socket - field replaceable - Plastic Transducers only
E	10 ft cable length - non-removable liquid-tight cable gland - not field replaceable - Plastic Transducers only
F	25 ft cable length - non-removable liquid-tight cable gland - not field replaceable - Plastic Transducers only
G	50 ft cable length - non-removable liquid-tight cable gland - not field replaceable - Plastic Transducers only
H	100 ft cable length - non-removable liquid-tight cable gland - not field replaceable - Plastic Transducers only
Z	No Cable - (use for transducers with field replaceable cable plug shipped without cable)

Nominal Pipe Size ⁴

IPS Pipe Size						Metric Pipe Size									
005	1/2" (plastic pipe only)	060	6"	181	18"	300	30"	021	20mm (plastic pipe only)	125	125mm	250	250mm	500	500mm
007	3/4"	020	2"	080	8"	201	20"	320	32"	026	25mm	051	50mm	140	140mm
010	1"	025	2-1/2"	100	10"	220	22"	340	34"	032	32mm	063	63mm	160	160mm
012	1-1/4"	030	3"	120	12"	240	24"	360	36"	041	40mm	075	75mm	180	180mm
015	1-1/2"	040	4"	141	14"	260	26"	420	42"			090	90mm	200	200mm
		050	5"	161	16"	281	28"	480	48"			110	110mm	225	225mm
												400	400mm	800	800mm
												450	450mm	101	1000mm

Pipe Pressure Rating ⁴

SK	Sch 5 (ASTM D 1785)	DA	SDR 41 (ASTM D 2241)	CA	Class 50 (ANSI C151)	TA	Sanitary Tubing 0.065" wall	PA	PN 4 metric (DIN 8062)
SA	Sch 10 (ASTM D 1785)	DB	SDR 26 (ASTM D 2241)	CB	Class 51 (ANSI C151)	TB	Sanitary Tubing 0.083" wall	PB	PN 6 metric (DIN 8062)
SB	Sch 20 (ASTM D 1785)	DC	SDR 21 (ASTM D 2241)	CC	Class 52 (ANSI C151)	TC	Sanitary Tubing 0.109" wall	PC	PN 10 metric (DIN 8062)
SC	Sch 30 (ASTM D 1785)	DD	SDR 19 (ASTM D 2241)	CD	Class 53 (ANSI C151)	TK	Type K copper (ASTM B 88)	PD	PN 16 metric (DIN 8062)
SD	Sch 40 (ASTM D 1785)	DL	SDR 18 (ASTM D 2241)	CE	Class 54 (ANSI C151)	TL	Type L copper (ASTM B 88)	PE	PN 20 metric (DIN 8062)
SE	Sch 60 (ASTM D 1785)	DE	SDR 17 (ASTM D 2241)	CF	Class 55 (ANSI C151)	TM	Type M copper (ASTM B 88)	BB	Class B British (BS 3506)
SF	Sch 80 (ASTM D 1785)	DF	SDR 15.5 (ASTM D 2241)	CG	Class 56 (ANSI C151)			BC	Class C British (BS 3506)
SH	Sch 120 (ASTM D 1785)	DG	SDR 13.5 (ASTM D 2241)					BD	Class D British (BS 3506)
SI	Sch 140 (ASTM D 1785)	DH	SDR 11 (ASTM D 2241)					DN	DR18 (AWWA C900 PVC PIPE)
SJ	Sch 160 (ASTM D 1785)	DI	SDR 9 (ASTM D 2241)					DM	DR25 (AWWA C900 PVC PIPE)
								BE	Class E British (BS 3506)
								B7	Class 7 British (BS 3506)

Pipe Material ⁴

A	Brass (naval)	E	Iron (ductile)	K	PVDF	O	Steel (1% Carbon, hardened)
B	Copper	G	Polyethylene (HDPE)	L	Stainless Steel 304	P	Steel (Carbon)
C	FRP (fiberglass reinforced plastic)	I	Polypropylene	M	Stainless Steel 304L		
D	Iron (cast)	J	PVC / CPVC	N	Stainless Steel 316		

Display Volume Units ³

G	U.S. Gallons	F	Cubic Feet	M	Cubic Meters	B	U.S. Barrels Liquid (31.5 Gal)	O	Ounces
L	Liters	A	Acre Feet	I	Imperial Gallons	P	U.S. Barrels Oil (42.0 Gal)	K	Milliliters

Display Time Units

M	Minutes	H	Hours	D	Days
----------	---------	----------	-------	----------	------

Fluid ⁴

AA	Alcohol (Ethyl alcohol; Ethanol)	AN	Water (sea; brine)	AL	Water (distilled; waste)	AJ	Oil (diesel)
AD	Ethylene Glycol / water (50%)	AI	Milk	AP	Wine	AE	Gasoline

Display Language (S4 models available in English only)

E	English	S	Spanish	G	German	F	French
----------	---------	----------	---------	----------	--------	----------	--------

S3 C 1 F B 120 SD P G M AL E **Sample Sonic-Pro Part Number**



Legacy Pumps & Instruments LLC
 PO Box 426, Mineral Wells, TX 76068-0426
 Phone 214-384-5303 or 817-793-0485
 www.legacypumpsllc.com